



# **IP Office**

## **4620/5620 Phone User Guide**

---

# Table of Contents

<b>The Telephone</b> .....	<b>4</b>
Overview.....	4
Call Appearance Keys .....	6
Call Appearance Keys Icons .....	7
System Features .....	7
<b>Basic Call Handling</b> .....	<b>8</b>
Answer Incoming Calls .....	8
Make a Call.....	8
Clearing a Call .....	8
Headset Working .....	9
Speakerphone .....	10
Mute.....	10
Hold .....	11
Speed Dial .....	11
Redial .....	11
Transfer .....	12
Conference.....	12
<b>Speed Dials</b> .....	<b>13</b>
Overview of Speed Dials .....	13
Accessing the Speed Dial Directory/Dialing a Speed Dial.....	13
Adding a Speed Dial from the Call Log .....	14
Editing a Speed Dial.....	14
Deleting a Speed Dial.....	14
Adding a New Speed Dial.....	15
<b>Using the Call Log</b> .....	<b>16</b>
Overview of the Call Log .....	16
To Access the Call Logs .....	17
To Display an Individual Log Entry .....	17
Making Calls from the Call Log.....	18
To Turn a Log Entry into a Speed Dial .....	18
To Delete an Individual Log Entry .....	18
To Delete All Entries from a Log.....	18
To Exit the Call Logs .....	18
Disabling the Call Log.....	18
<b>Changing Options</b> .....	<b>19</b>
Personal Ringing .....	19
View IP Settings .....	19
Contrast Control .....	20
Logging Off.....	20
Reinstating the Phone .....	20
Feature Button Labeling .....	21
Display Language Selection .....	22
Phone Screen on Answer.....	23
Phone Screen on Calling.....	23
Display Call Timers.....	23
Message Display Rate.....	24
Call Appearance Width.....	24
Visual Alerting.....	24
<b>Function Keys</b> .....	<b>25</b>
Overview of the Function Keys.....	25
Function Key Programming .....	26
Shorthand Programming Mode .....	27
Longhand Programming Mode .....	28

---

<b>System Features .....</b>	<b>29</b>
Introduction .....	29
Making Calls .....	29
Answering Calls .....	29
Call Waiting .....	30
Call Forwarding .....	30
Diverting Calls .....	30
Do Not Disturb .....	31
Voicemail .....	31
Default Feature Codes .....	32
<b>Web Browsing .....</b>	<b>33</b>
Overview of Web Browsing .....	33
Accessing External WAP Websites .....	33
Web Navigation Controls .....	34
Entering Data .....	35
<b>Management and Troubleshooting.....</b>	<b>36</b>
Overview .....	36
Testing the Telephone's Lights and Display .....	36
Troubleshooting .....	37
<b>Index.....</b>	<b>39</b>

---

# The Telephone

---

## Overview

This guide covers the use of the Avaya 5620 and 4620 telephone on Avaya IP Office telephone system. These two phones are physically similar, the key difference being that the 5620 is only supported on the IP Office where as the 4620 is supported on a range of Avaya phone systems.

The diagram below shows the main telephone features.



**1. Display and Feature buttons:**

The Call Appearance Keys allow the user to handle multiple calls with the display showing call information, e.g. the name/phone number, etc. There are four pages in the display; giving up to 24 system features that can be allocated to the function keys. See Call Appearance Keys and Overview of the Function Keys. The information displayed varies according to the active feature.

**2. Message waiting lamp:** Used as follows;

- **On (Continuous):** There are new messages in your voicemail mailbox, or in another mailbox for which you have been configured to receive "Message Waiting Indication".
- **Flashing:** The lamp can also be set to flash when the phone receives a call. See Visual Alerting.





**3. ◀▶Page Right/Left:**

Shifts from one page to another in the same application when the display presents the paging indicator (↔). These buttons have no effect when the paging indicator is not displayed.

**4. Options:**

Displays the Options main screen, from which display and application settings can be updated

**5. Call Handling Buttons:**

-  **Hold:** Red button used to place a call on hold.
-  **Transfer:** Transfers a call to another phone.
-  **Conference:** Sets up conference calls with more than one other person.
-  **Drop:** Drops the current call or, if on a conference call, drops the last person to join the conference.
-  **Redial:** Redials the last number dialed or displays the last 6 numbers dialed from the phone, depending on configuration via the Options menu.

**6. Numeric (Dialing) Pad:**

Standard 12 button pad for dialing phone numbers.

**7. ▼▲Volume Controls:**

Adjusts the handset, speaker, headset, or ringer volume, depending on which item is in use. As you increase or decrease the volume, the top display area provides either a speaker, headset, handset, or ringer icon to indicate for which item you are adjusting volume, followed by a visual "volume meter" showing the volume level. These buttons also control the volume of the key click sounds made when you press fixed buttons on the phone, such as the dial pad or softkeys.

**8. 🔇 Mute and LED Indicator:**

Turns off the active Speaker, handset, or headset microphone to prevent the other person from hearing you. The associated LED lights steadily when the handset or headset is muted.

**9. 🎧 Headset and LED Indicator:**

With a headset connected, changes audio control from the handset or speaker to the headset. The associated LED lights steadily when the headset is active. The headset jack socket is located on the base of the telephone underneath the front edge.

**10. 🗣️ Speaker and LED Indicator:**

Accesses the Speaker feature. The associated LED lights steadily when the Speaker is active.

**11. 📞 Phone/Exit:**

Displays the phone application main screen or, if applicable, exits the current IP Office based feature, such as Speed Dial or Call Log, and normalizes the display

**12. ○ Softkeys:**

Used to navigate to or initiate certain features, such as Speed Dial or Call Log, as well as control certain actions within the features. These keys correspond to the text prompts in the display screen immediately above them.

## Call Appearance Keys

There are four pages of Call Appearance and Function Keys. You can step through these with the  keys. At default, first page of the main call screen contains three keys set as 'call appearance' keys. With these keys the phone is a multi-line phone and are indicated as **a=**, **b=** and **c=**. The remaining 21 Function Keys can have system features allocated to them, by your System Administrator, that are specific to your requirements (see Function Keys).

Your System Administrator can change a call appearance key with:

- **A Bridged Appearance**  
A bridged appearance key matches the status and operation of the Call Appearance Key on a pre-defined colleague's telephone. Hence, you can pick-up, make and receive calls on behalf of your colleague.
- **A Line Appearance**  
An IP Office exchange line (but not IP lines) can be allocated to you such that the status of that line is displayed and you can use the line appearance key to make and receive calls.
- **Call Coverage Appearance**  
A call coverage appearance key alerts you when a pre-defined colleague is receiving a call. The covered user does not need to be using call appearance keys. Hence, you can pick-up calls on behalf of your colleague. · A System Feature
- **System Features:**  
System Features, such as Abbreviated Dial (that automatically dials a frequently used number) can be set against key and/or dial pad digits.  
See Function Keys.

**All of the above can only be allocated to you by your System Administrator.**

For details of Bridged, Line and Call Coverage Appearance Keys set-up and their operation, refer the *IP Office Key and Lamp Operation* manual.

### CAUTIONS:

1. Having more than two Call Appearance keys is very useful. When holding a call you can answer/make another call and then switch between calls or transfer or conference. If you are set to receive call waiting indication, the waiting call is shown against the next call appearance key.
2. Although the System Administrator can replace the Call Appearance Keys with:
  - A Bridged Appearance
  - A Line Appearance
  - Call Coverage Appearance
  - System Features















This would severely restrict the use of features such as conference and transfer.

It is for these reasons that it is **strongly recommended** that all Call Appearance keys **remain at their default settings**.

---

## Call Appearance Keys Icons

The icons displayed against the Call Appearance/Feature Keys allow you to determine the status (for example, on Hold) of each call. Icons also indicate whether a feature has been activated for a particular button.

- **Incoming Call:**  A  symbol next to a call appearance key indicates an incoming call. Pressing the adjacent   key answers the call and puts any other current call on hold.
- **Connected:**  A  symbol next to a call appearance key indicates that it is the currently connected call. The caller's telephone number (if available) is also shown. Pressing the adjacent   key puts the call on hold. An **H** is also shown on the display.
- **On Hold:**  A  symbol next to a call appearance key indicate a call on hold. Pressing the adjacent   key takes the call off hold and puts any other current call on hold.
- **Function Active:**   The button to the left or right of the function key is active.

---

## System Features

System Features **can only be** set against soft Function Keys by your System Administrator. However, your System Administrator may allocate you two 'self administrator' features that will enable you to add System Features to your soft Function Keys. Refer to Overview of the Function Keys for details of the System Feature that **can only be allocated to you** by your System Administrator.

In addition, there are a number of System Features that you can always access yourself by the use of short codes. Refer to System Features Introduction for details of System Features that you can always access yourself by dialing short codes, e.g. \*17 to listen to your voicemail messages.

---

# Basic Call Handling

---

## Answer Incoming Calls

When there is an incoming call, you will hear a ringing tone and a blinking bell icon appears on the associated call appearance screen.

To answer an incoming call, do one of the following:

### Answering the first incoming call

1. Pick up the handset or press the  button to use the speakerphone.

### Answering waiting calls

1. If you have call waiting switched on, the waiting call is shown against the next call appearance key and a tone is played to further indicate the waiting call. If you choose to answer the waiting call, press the  button corresponding to waiting call and the current call will be placed on hold.

---

## Make a Call

There are several options for making a phone call, depending on what how you want to use the phone.

### Making a call using the handset

1. Pick up the handset.
2. Dial the phone number of the person you want to contact, including any outside line digits and/or area codes.

### Making a call using speakerphone

1. Press .
2. Dial the phone number of the person you want to contact, including any outside line digits and/or area codes.
3. See Speakerphone for more information on using the speakerphone.

### Making a call using speed dial

1. See Using Speed Dials.

---

## Clearing a Call

To clear an established call either:

1. Replace the handset

or

2. Press  **Drop**. You will hear dial tone, unless you are in 'call center mode' of working when you will then hear silence.



---

## Headset Working

When a headset is to be used, it must be plugged in to the headset socket on the base of the phone. To activate the headset and switch off the handset, press  **Headset**. The lamp beside the button is illuminated when headset working is activated.

### To answer an incoming call:

1. Press the call appearance key  next to the flashing bell icon ():

### To clear a headset call:



1. Press  **Drop**.

### To manually make a call:

1. Dial the number (remember to include the required access code (for example, 9) for an outside line) and listen to the progress of the call.

### To automatically make a call:

Do any of the following:

- Press  Redial and a call appearance key  to have the telephone dial the last number that you dialed. See Redial.

or

- Access the Call Log and initiate a call to a specific entry. See Making Calls from the Call Log.



or

- Access the Speed Dial List in your personal directory and initiate a call to a specific entry. See Dialing a Speed Dial Number.
- When the call is answered, speak to the called party.

## Speakerphone

The two-way built-in speakerphone allows you to make and answer calls without lifting the handset. Keep in mind that two-way speakerphones may not operate satisfactorily in every environment (such as in very noisy locations).

### Using the speakerphone with any feature:

1. Press .
2. Make or answer the call, or access the selected feature.
3. Adjust the speakerphone volume if necessary.
4. To change the volume, use the  and  buttons. The display bar at the top of the display screen shows the volume level. (There are eight volume levels.)

### Changing from speakerphone to handset:

1. Pick up the handset and continue talking.

### Changing from handset to speakerphone:

1. Press .
2. Hang up the handset.

### Ending a speakerphone call:



1. Press  again.

---

## Mute

During an active call, the Mute feature prevents the party with whom you are speaking from hearing you. This feature is most commonly used in conjunction with the Speakerphone, but can be used to hold an off-line conversation at any time during a call.

### Preventing the other person on the line from hearing you



1. Press  **Mute**.
2. The other party cannot hear you. The indicator next to the Mute button lights when Mute is active.
3. To reinstate two-way conversation, press  **Mute** again.

---



## Hold

The Hold feature puts a call on hold until you retrieve it.

### Placing a call on hold

1. Press the  **Hold**.
2. The line display area changes to white text with a dark gray background, and the  hold icon displays.

### Retrieving the held call



1. Press the corresponding  Line/Feature button on which the call is being held, or press the  **Hold**.
2. The call is now active.

---

## Speed Dial

The Speed Dial feature allows the phone to dial numbers stored in your personal directory (maximum of 104).

### To make a call to a personal directory entry using the Speed Dial feature



1. From the Home screen, press the  **SpDial** softkey. The **Speed Dial** screen is displayed.
2. Press the button next to the entry you want to call.
3. If the entry you want is not displayed, use  and  to cycle through the entries **or** key the first letter of the required name to jump to the page with a matching entry.
4. The telephone dials the number for you.

---





## Redial

The Redial feature automatically redials a previously dialed extension or outside number (up to 24 digits). The phone can store the up to six of the last numbers dialed.

### To redial previously dialed number:

1. Press  **Redial**. Use  and  to step through the entries. When you have located the required number, press the associated key.





### To change the Redial number selection:

1. Press  **Option** and select  **Application Options**.
2. Select  **Redial**. It will toggle between **Last 6 Numbers** and **Last Number**.
3. Select  **Save**. To restore the previous setting without changing it, press  **Cancel**.

## Transfer

The Transfer feature lets you transfer a call from your telephone to another extension or outside number.

### Transferring a call to another telephone



1. With the call active (or with only one held call and no active calls), press the  **Transfer**.
2. The call is placed on hold; the  **Hold** icon displays and you hear a
3. dial tone while the next available line activates.
4. Dial the number to which you want to transfer the call.
5. If you do not want to announce the call, press the  **Transfer** again and proceed to Step 6. If you wish to wait for an answer and announce the call, go to Step 7.
6. The call is sent to the extension or number you dialed. A two-second display message indicates the transfer is complete.
7. Remain on the line and announce the call; if the line is busy or if no one answers, return to the held call by pressing the Call Appearance/Feature button on which it is being held.
8. Press  **Transfer** again.
9. The call is sent to the extension or number you dialed. A two-second display message indicates the transfer is complete.
10. Hang up your handset.

---





## Conference

The number of conferences available is dependent on the IP Office unit set up on your system.

### Adding another party to a call

1. Dial the first party, then press  **Conference**.
2. The line display area changes to white text with a dark gray background. The current call is placed on hold, the  Soft Hold icon displays and you hear a dial tone.
3. Dial the number of the next party and wait for an answer.
4. Press  **Conference** again to add the new party to the call.
5. Repeat Steps 1- 3 for each party you want to conference in to the call.

### Adding a held call to the current call

1. Press  **Conference**.
2. The icon on the current line changes to the  Soft Hold icon.
3. Press the  Call Appearance/Feature button corresponding to the held call.
4. Press the  **Conference** button again.
5. All parties are now connected.

### Dropping yourself from the conference

1. Press the  **Drop** button.
2. Disconnects the line on which the drop button is pressed.

---

# Speed Dials

---

## Overview of Speed Dials

The phone can store up to 108 personal speed dials, accessed by selecting **SpDial** on the display.

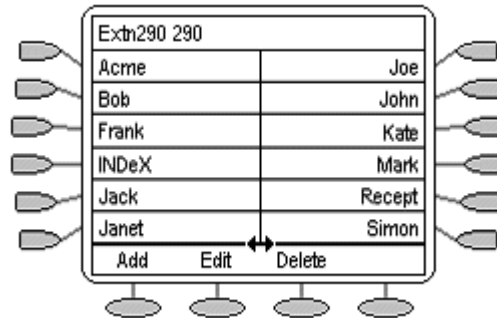

- The speed dials are sorted alphabetically.
- Pressing the **[key]** or **[key]** key adjacent to an name, dials the speed dial number stored with that name.
- The **↔** symbol indicates that there are more pages. You can move between pages using the **◀ Page Left** and **▶ Page Right** keys.

Pressing **Add** allows you to add a new speed dial. You can also press **Edit** and an existing speed dial to edit its current settings.

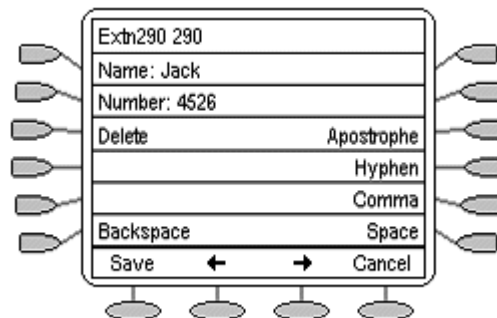

**Note:** Speed dials can be used for any numbers that can be manually dialed from the extension. If for external calls, a dialing prefix is required; that prefix must be part of the speed dial number.

---

## Accessing the Speed Dial Directory/Dialing a Speed Dial

You can use the speed dial directory to make a call with the handset on hook or off hook.











1. Press **SpDial** to display the speed dial directory.
  - If **SpDial** is not shown, you may have to press **Phone Exit** to exit the current screen function.
2. The **↔** symbol is shown if there is more than one page of speed dials. You can move between pages using the **◀ Page Left** and **▶ Page Right** keys.
3. When the speed dial required is shown on the screen, press the **[key]** or **[key]** key adjacent to the speed dial name.
4. Continue as per a normal call.

## Adding a Speed Dial from the Call Log











You can create a new speed dial from a call log entry. See [To Turn a Log Entry into a Speed Dial](#). This process will start the normal speed entry screen but pre-filled with the name and number from the call log entry.

---

## Editing a Speed Dial

1. Press  **SpDial** to display the speed dial directory.
  - If **SpDial** is not shown, you may have to press  **Phone Exit** to exit the current screen function.
2. The  symbol is shown if there is more than one page of speed dials. You can move between pages using the  **Page Left** and  **Page Right** keys.
3. Go to the page containing the speed dial to edit.
4. Press  **Edit**.
5. Press the  or  key next to the speed dial to edit. The editing process is similar to adding a new speed dial, see [Adding a New Speed Dial](#).
  - When editing an existing speed dial, a  **Delete** option is provided to remove the speed dial from the speed dial directory. When selected press  **Delete** to confirm or  **Cancel** to exit without deleting.

## Deleting a Speed Dial

1. Press  **SpDial** to display the speed dial directory.
  - If **SpDial** is not shown, you may have to press  **Phone Exit** to exit the current screen function.
2. The  symbol is shown if there is more than one page of speed dials. You can move between pages using the  **Page Left** and  **Page Right** keys.
3. Press  **Delete**.
4. Press the  or  key next to the speed dial to delete.
5. Press  **Delete** to confirm the deletion. Press  **Cancel** to exit without deleting.

## Adding a New Speed Dial

1. Press **SpDial** to display the speed dial directory.
  - If **SpDial** is not shown, you may have to press **Phone Exit** to exit the current screen function.
2. Press **Add**.

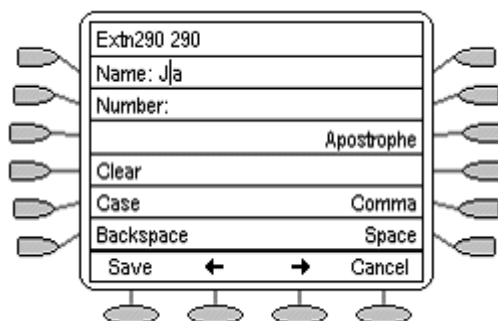

3. The cursor, a | symbol, is initially in the empty name field. You can move between Name and Number entry by pressing the adjacent **←** key.
4. Begin entering text using the telephone keypad. Each key is marked with the letters it provides. You may have to press the key more than once depending on the character you require.
  - For example, the **2** key is also marked as **A**, **B** and **C**. To enter a **C** press the key until a **C** is displayed.
  - If the next character you want to enter is on the same key, press **→** and then enter the next character.
5. As you enter characters you can use a number of other controls. Note: The controls on this screen are context sensitive, ie. they only appear when applicable. For example **Save** only appears when a name and number have been entered.
  - **Save** - Save the speed dial changes.
  - **←** - Moves the cursor left one character.
  - **→** - Moves the cursor right one character.
  - **Cancel** - Return back to the speed dial directory without making any changes.
  - **Clear** - Delete the whole name or number entry.
  - **Case** - Change the case of the current character between upper and lower case.
  - **Backspace** - Delete the character before the cursor.
  - **Apostrophe** - Insert an apostrophe (') symbol.
  - **Comma** - Insert a comma (,) symbol.
  - **Space** - Insert a space.

---

# Using the Call Log

---



## Overview of the Call Log

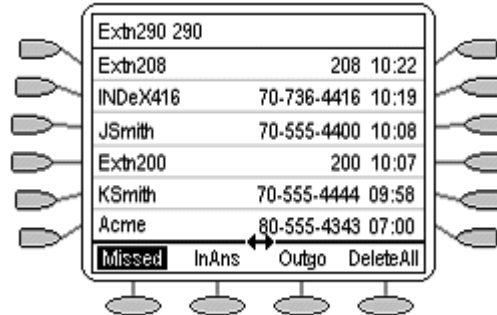

The phone maintains a call log, accessed by selecting  **Log** on the display.

The call logs keeps logs of missed calls, outgoing calls made and incoming calls answered. Each of these logs includes the 30 most recent calls in each category. The details shown are:



Extn290	290	
Extn208	208	10:22
INDeX416	70-736-4416	10:19
JSmith	70-555-4400	10:08
Extn200	200	10:07
KSmith	70-555-4444	09:58
Acme	80-555-4343	07:00
Missed InAns Outgo DeleteAll		

- The name of the called or calling party if available.
- The number of the called or calling party.
- The time of the call.
- The date of the call if prior to the current day.
- The  symbol indicates that the log contain more pages of entries. You can move between pages using the  **Page Left** and  **Page Right** keys.

Pressing the  or  key adjacent to a log entry displays full details of that log entry: Each individual log entry includes:

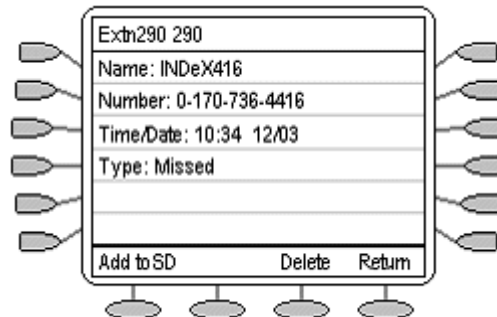

Extn290	290
Name:	INDeX416
Number:	0-170-736-4416
Time/Date:	10:34 12/03
Type:	Missed
Add to SD Delete Return	

- The name of the called or calling party if available.
- The number of the called or calling party.
- The time of the call.
- The date of the call.
- The duration of the call for outgoing and answered calls.

Apart from using the call logs for information, you can turn a call log entry into a speed dial for future calls. You can also delete individual log entries or the all entries in a particular log.





**Note:** Call log entries are lost whenever the telephone system or the individual telephone are reset.



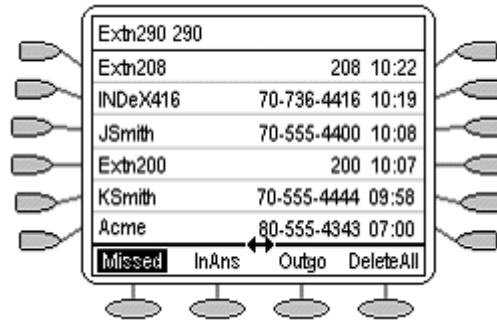

## To Access the Call Logs

1. Press the  key under **Log**.



- If **Log** is not shown, you may have to press  **Phone Exit** to exit the current screen function.
2. The call log always opens in the **Missed** calls log.
  3. To select the log required press the  key under **Missed**, **InAns** or **Outgo**.
    - **Missed:** The log of missed calls, ie. those that rang your extension but were not answered. This includes calls that were diverted to voicemail or another number after ringing your extension.
    - **InAns:** The log of incoming calls that were answered. This includes both internal and external calls.
    - **Outgo:** The log of calls made. This includes both internal and external calls.
  4. If the selected log contains more than one page of entries, the  is shown. Use the  **Page Left** and  **Page Right** keys to move between pages.





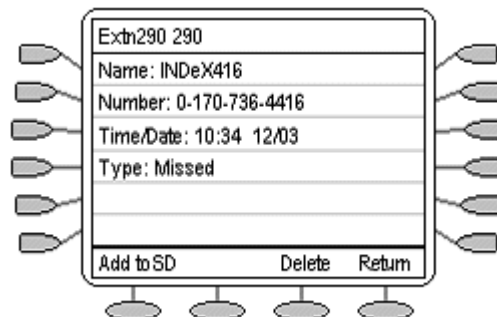

## To Display an Individual Log Entry

1. Locate the log entry in which you are interested.
2. Press the  or  key adjacent to the entry.
3. The log entry details are shown.







4. Using  **Return** key to return to the call log.





## Making Calls from the Call Log

1. Locate the log entry in which you are interested from ,  or .
  2. Press the  or  key adjacent to the entry.
  3. The log entry details are shown.
  4. Press  **Call** make the call. If the number shown is external but doesn't include the external dialing prefix used by your telephone system, go off-hook, dial the prefix and then press  **Call**.
- 







## To Turn a Log Entry into a Speed Dial

1. Locate the log entry and press the  or  key adjacent to it.
  2. Press  **Add to SD**.
  3. The screen for editing and adding speed dials will appear, prefilled with the information from the log entry. Edit the details if required and press  **Save** or  **Cancel**.
  4. You will be returned to the speed dials selection menu.
- 

## To Delete an Individual Log Entry

1. Locate the log entry and press the  or  key adjacent to it.
  2. Press  **Delete**.
  3. Press  **Delete** to delete the log entry. Press  **Cancel** to return to the call log without deleting the log entry.
  4. You will be returned to the call log.
- 

## To Delete All Entries from a Log

1. Press ,  or  to select the log.
  2. Press the  key under **DeleteAll**.
  3. Select  **Delete** to delete the log entries. Press  **Cancel** to return to the call log without deleting the log entries.
- 







## To Exit the Call Logs

1. Press  **Phone Exit**.
- 

## Disabling the Call Log

The phone's call logging can be switched off if required.

### To disable call logging:

1. Press  **Option** and select  **Application Options**. Press .
2. Select  **Call Log**. It will toggle between **Enabled** and **Disabled**.
3. Select  **Save**. To restore the previous setting without changing it, press  **Cancel**.

---





# Changing Options

---

## Personal Ringing

The IP Office uses 'distinctive ringing' for different types of calls - a repeated single ring for internal calls, a repeated double ring for external calls and a single ring followed by two short rings for ringback calls. These options are fixed by the IP Office. The phone's own menus allow its ringer sound to be personalized so you can recognize it from other ringing phones.

**To hear a ring pattern and change the Personal Ringing options:**





1. Press  **Option** and then select  **Personal Ringing**. This alters the tone and style of ringing used by the phone, the ring pattern is still controlled by the IP Office according to the call type.
2. Select the corresponding  button to the left or right of any numbered pattern. The **Current Pattern** number changes to the selected pattern, which rings once as a sample.
3. Repeat Step 1 until the preferred pattern appears as the **Current Pattern**.
4. Save the setting by pressing the  **Save**.
5. Upon saving or canceling, the first Options Main screen displays.

---

## View IP Settings

Views of telephone and system information are available from this screen. A user normally does not need to view this information, however your System Administrator may ask you to report certain values from any of the status screens in the event of problems.

The status screen data can be viewed, but cannot be changed.







1. Press  **Option**) and then select  **View IP Settings**.
2. There are two pages of display. Use  and  select from:
  - **IP Address Settings**  
IP (Internet Protocol) address information identifies certain components and connections. The IP Address information includes the location (address) of your phone on the IP Office unit, the location and port (connection) of the IP Office itself, the call routing and mask addresses, and the identification of the File Server with which your telephone interacts. Although technical in nature, having this information available and knowing how to get to it can assist your System Administrator in tracking questions about or problems with phone functions or connections.
  - **Quality of Service (QoS) Information**  
QoS refers to a number of mechanisms used to improve audio quality over the network.
  - **Phone Interface**  
Your phone interfaces with several system hardware devices and software. This screen provides information about three of the main interfaces.
  - **Miscellaneous Information**  
The miscellaneous status screens provide additional information about your telephone and its connections.
3. To return to the first **View IP Settings** screen, press  **Return**.

## Contrast Control

On first-time startup, the phone's display area contrast is set to a mid-level. Should you need to adjust it to better suit your work environment and lighting, 15 contrast levels are available.

**NOTE:** You may not be able to distinguish between all 15 contrast level settings. Some of the upper and/or some of the lower contrast level settings may appear identical to adjacent settings. This is normal.

### To adjust the contrast level:

1. Press  **Option**) and then select  **Contrast Control**.
2. To adjust the contrast, use  or  until you reach the desired contrast level. ( symbols provide visual confirmation of the current level.)
3. Save the contrast level you set by pressing the  **Save**, or, to restore the previous setting without changing the contrast, press the  **Cancel**.





---

## Logging Off

Allows you to log your telephone off to prevent unauthorized use during an absence, or for privacy purposes

- **CAUTION:** Logging off deletes all call log entries and returns any options you may have changed to their default values.

### To log your phone off:

1. Press  **Options** and then select  **Log Off**.
2. Select  **Yes** to un-register your phone from the IP Office, delete all Call Log entries and returns any options you may have configured to their default values.
3. Selecting  **No** returns you to the main Option menu; your phone remains logged on to the network and your Call Log and options values remain unchanged.

---

## Reinstating the Phone

When your phone not registered on the phone system, the top line displays "Extension=\*."















### To reinstate your phone following a log off:

1. The telephone screen displays your extension number. Press the Hash (#) key. If the screen does not display your extension number, use the dialpad to enter the number, then press the Hash (#) key.
2. The display prompts for entry of your password. Using the dialpad, enter your PBX/switch Password then press the Hash (#) key.
3. The phone is now ready for use.

---

## Feature Button Labeling

This feature can be used to edit and change the text label shown next to buttons.

1. Press  Options. Press  and then  **Feature Button Labeling**.
2. Select from:
  - Relabel feature buttons: proceed from next step:
  - View Default labels
  - Restore default labels: restores any previously renamed feature labels to their default state.
3. Select the function key whose label you wish to change. The display will change to show the editing menu with **New:** highlighted.
4. Begin by entering the new text using the telephone keypad. Each key is marked with the letters and number it provides. You may have to press the key more than once depending on the character you require.
  - For example, the key 3 is also marked as **D**, **E** and **F**. To enter an **D**, press **3**.
  - If the next character you want to enter is on the same key, press  to move the cursor right and then enter the character. Alternatively, simply key the next character.
  - By default the first letter is entered in upper-case and the phone then switches to lower-case entry mode. To change the case of the current character press  **Case**.
  - To enter a space press  **Space**.
  - If you make a mistake, use the  **Backspace** key to delete the character to the left of the cursor.
  - If you have make a mistake in the middle of the text, use the  key to backspace and then the  **Backspace** key to delete the character to the left of the cursor.
  - To delete the complete entry use the  **Clear** key.
  - You can also enter an Apostrophe, Hyphen or Comma as required.
5. When the new name is set as required, press  **Save**.
6. To return to the Label screen without saving the changes press  **Cancel** and to return the main Options menu press  **Return**.
7. To return to the call handling screen without saving the changes press  **Exit**.







## Display Language Selection

Non-English speaking users can change the user interface language displayed on their phone.

Language options are:

- English, Français, Italiano, Japanese (Katakana characters), Español, Deutsche, Nederlands, Português.

**Note:** This does not alter your user language setting on the telephone system.

1. Press  **Option**,  and  **Language**. A menu listing the available languages appears.
2. Press the  or  key next to the language required. You are asked in the original language “Are you sure?” with the same message in the new language below.
3. Do one of the following:
  - To return to the options menu without saving any changes, press  **Return**.
  - To save the settings and return to the options menu, press  **Yes** (which is displayed in both the original and the selected language).

---

## Phone Screen on Answer

This action controls the phone screen display when the phone is answered.

When the **Phone Screen on Answer?** option is set to **Yes**, the phone screen appears in the display area when you answer a call, regardless of the screen you were working with at that time. You will lose any unsaved work in progress on that screen (for example, labeling a Speed Dial button), except for the Web Access application (which "remembers" the current web screen).

When the **Phone Screen on Answer?** option is set to **No** (the default setting), answering an incoming call has no impact on the application screen displayed, although the top display line will provide an appropriate message.

### To change Phone Screen on Answer:

4. Press  **Option** and select  **Application Options**.
5. Select  **Phone Screen on Answer**. It will toggle between **Yes** and **No**.
6. Select  **Save**. To restore the previous setting without changing it, press  **Cancel**.

---

## Phone Screen on Calling

This action controls the phone screen display when you make a call.

When the **Phone Screen on Calling?** option is set to **Yes** (the default setting), the phone screen appears in the display area when you make a call, regardless of the screen you were working with at that time. You will lose any unsaved work in progress on that screen (for example, labeling a Speed Dial button).

When the **Phone Screen on Calling?** option is set to **No** answering an incoming call has no impact on the application screen displayed, although the top display line will provide an appropriate message.

### To change Phone Screen on Calling:

1. Press  **Option** and select  **Application Options**.
2. Select  **Phone Screen on Calling**. It will toggle between **Yes** and **No**.
3. Select  **Save**. To restore the previous setting without changing it, press  **Cancel**.

---

## Display Call Timers

This action controls whether the duration of the current call is displayed or not. If set to **Yes**, the duration of the current call is displayed on the call appearance key. If set to **No**, the call duration will not be displayed.





### To change the Display Call Timers status:

1. Press  **Option** and select  **Application Options**.
2. Select  **Display Call Timers**. It will toggle between **Yes** and **No**.
3. Select  **Save**. To restore the previous setting without changing it, press  **Cancel**.

## Message Display Rate

When the IP Office sends messages to your phone that are longer than the display area, the first part of the message is presented for a specific time interval. The second part of the message is then displayed for a specific time interval. The Message Display Rate can be either **Fast** (display interval is 2 seconds) or **Slow** - default (display interval is 3 seconds).

### To change Message Display Rate:





1. Press  **Option** and select  **Application Options**.
2. Select  **Display Call Timers**. It will toggle between **Fast** and **Slow**.
3. Select  **Save**. To restore the previous setting without changing it, press  **Cancel**.

---

## Call Appearance Width

When the Call Appearance Width is set to **Full** (the default), each line on which a call appears extends the full width of the display, and accommodates messages in the call appearance display area. When this option is set to **Half**, the call appearance area is limited to half of the display area and call-related messages appear on the top display line.

### To change Call Appearance width:







1. Press  **Option** and select  **Application Options**.
2. Select  **Call Appearance Width**. It will toggle between **Full** and **Half**.
3. Select  **Save**. To restore the previous setting without changing it, press  **Cancel**.

---

## Visual Alerting

When this option is set to **No** (the default), ringing is the only notification of an incoming call. When set to **Yes**, your phone rings and your voice message indicator light flashes to alert you to an incoming call.

### To change Visual Alerting:

4. Press  **Option** and select  **Application Options**. Press .
5. Select  **Visual Alerting**. It will toggle between **Yes** and **No**.
6. Select  **Save**. To restore the previous setting without changing it, press  **Cancel**.





---

# Function Keys



---

## Overview of the Function Keys

Both ,  Function Keys and  Soft Keys can be used to access a range of system features. The display adjacent to the key shows the feature name.





Some of these features are default features, for example **SpDial**, **Log** and **Option** which are always available. Others are system features that **can only be programmed by the System Administrator** for Function Keys. See Function Key Programming.

In addition, there are a number of System Features that you **can always access yourself** by the use of short codes. Refer to System Features Introduction for details of System Features that you can always access yourself by dialing short codes, e.g. **\*17** to listen to your voicemail messages.

The main screen has four pages. This means that the eight  and  Function Keys on each page could be used for up to 24 features. However, it is **strongly recommended** that all three Call Appearance keys **remain at their default settings**. Hence, there are 21 soft Function Keys that can be allocated to system features.

To move between pages use the  and  keys.

In the following example:

- The first three keys have been set as call appearance lines.
- Keys 4 and 5 have been set to access the **Admin** and **Admin1** programmable functions.
- Key 6 has been set to monitor system park slot 1. The  indicates a call is currently parked in slot 1.
- Key 7 has been set to the SAC (Send All Calls) function.
- Key 8 has been set to VMOn, a function which toggle use of the user's voicemail mailbox on/off. The  indicates that this function is currently on.
- Pressing either  or  would display the other two pages of programmed functions set for this phone.

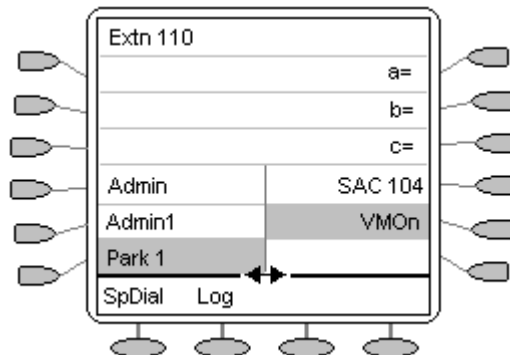

### Programming Your Own Features:

If the phone has been setup with either or both the Admin and Admin1 features assigned to display keys, you can select and program your own feature choices against other keys. See Function Key Programming.

## Function Key Programming

If any one of the keys on the telephone is programmed with an **Admin** or **Admin 1** feature, it allows you to program further features against other function keys. Both **Admin** and **Admin1** are allocated to your function keys by your System Administrator and would appear on a menu screen that is similar to the following:

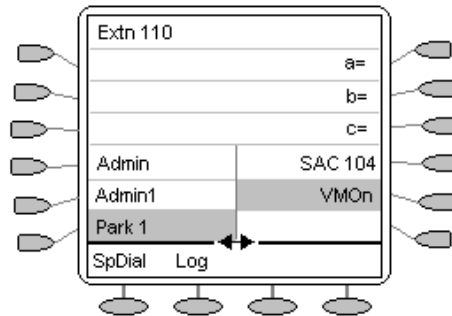

The two tables below list the user programmable features available from **Admin** and **Admin1**. For full details of how each function works see System Features.

**Admin:** The programmable functions available via an **Admin** key are:

Name	Description	Toggles	Data
Acct	Account Code Entry	No	Optional
AD	Abbreviated Dial	No	Yes
Admin	Self-Administer	No	No
AutCB	Automatic Callback	Yes	No
CFrwd	Call Forwarding All	Yes	Optional
CPark	Call Park	Yes	Optional
CPkUp	Call Pickup	No	No
Dir	Directory	No	No
DPkUp	Directed Call Pickup	No	Yes
Drop	Drop	No	No
GrpPg	Group Paging	No	Yes
HdSet	Headset Toggle	Yes	No
HfAns	Internal Auto-Answer	Yes	No
HGNS+	Set Hunt Group Night Service	No	Yes
Park	Call Park to Other Extension	No	Yes
Prog	Abbreviate Dial Program	No	Yes
RngOf	Ringer Off	Yes	No
SAC	Send All Calls	Yes	No
Spres	AD Suppress	Yes	No
Timer	Timer	Yes	No
TmDay	Time of Day	Yes	No

In addition to the above, there is a key labeled **Exlp?** This key enables you to change the display from the shorthand version displayed at default to a longhand version of your own. See Shorthand Programming Mode and Longhand Programming respectively.

**Admin1:** The programmable functions available via an **Admin1** key.

Name	Description	Toggles	Data
Park	Park	No	Yes
User	User	No	Yes
Group	Group	No	Yes
Number	Dial	No	Yes
Flash	Hook Flash	No	No

## Shorthand Programming Mode

1. Press **Admin** or **Admin 1**. See Display Key Programming.
2. The **Admin** or **Admin1** menu appears as follows:

### Admin Pages

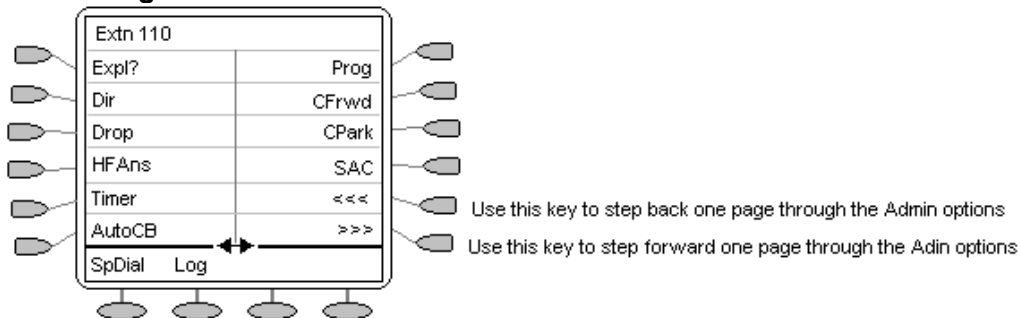

With the exception of **Expl?**, the names shown are the features that you can assign to soft keys. When **Admin** has been selected you can display the full name of the feature by pressing **Expl?**. See Longhand Programming.

### Admin1 Page

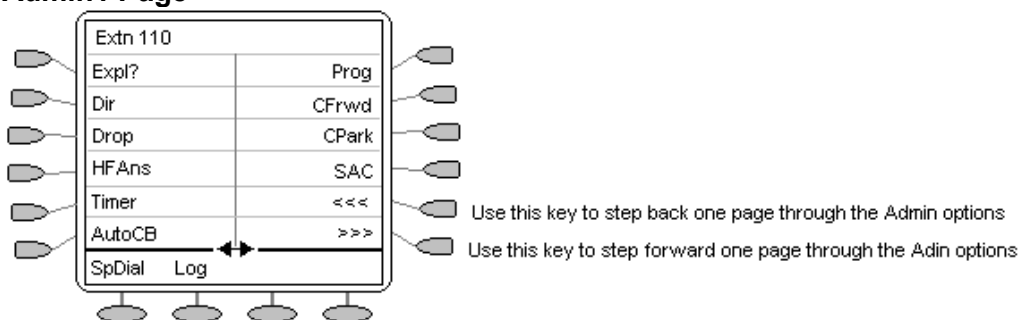

3. On the **Admin** pages, use the and keys to move through the list of feature.
4. When the function required is shown, press the key adjacent to its name.
5. If the function requires some data to be entered, [ is shown at the bottom of the display. Enter the data using the normal telephone keypad.
6. The upper part of the display reverts to showing the functions currently assigned to each and key.
7. Select the display key against which to program the new function by pressing that or key.
  - **Caution:** Do not select the slot used for the **Admin** function. Replacing this function will lock the phone for further programming until reset through the telephone system.
8. If the display slot is not already used, the display shows **BUTTON PROGRAMMED!**
  - Press **EXIT** to end programming.
  - Press **Cont** to continue programming other functions.
9. If the display slot already has a programmed function, the display shows **FEATURE ON BUTTON**. Press the or keys until **Repla**, **Keep** and **Delet** are shown along the right-hand edge of the display.
  - Press **Repla** to replace that existing function with the one just programmed. The display then shows **BUTTON PROGRAMMED!** as above.
  - Press **Keep** to keep the existing function and forget the function just programmed.
  - Press **Delete** to delete the existing function and forget the function just programmed.

## Longhand Programming Mode

1. Press **Admin** or **Admin 1**. See Display Key Programming. .
2. Pressing **Expl?** to switch to longhand programming mode.
3. Press **Next** until the required function required is shown, then press **Select**.
4. If the function requires some data to be entered, [ ] is shown at the bottom of the display. Enter the data using the normal telephone keypad.
5. The upper part of the display reverts to showing the functions currently assigned to each and key.
6. Use the **◀** and **▶** keys to move between the pages of display keys.
7. Select the display key against which to program the new function by pressing that or key.
  - **Caution:** Do not select the slot used for the **Admin** function. Replacing this function will lock the phone for further programming until reset through the telephone system.
8. If the display slot is not already used, the display shows **BUTTON PROGRAMMED!**
  - Press **EXIT** to end programming.
  - Press **Cont** to continue programming other functions.
9. If the display slot already has a programmed function, the display shows **FEATURE ON BUTTON**. Press the **◀** and **▶** keys until **Repla**, **Keep** and **Delete** are shown along the right-hand edge of the display.
  - Press **Repla** to replace that existing function with the one just programmed. The display then shows **BUTTON PROGRAMMED!** as above.
  - Press **Keep** to keep the existing function and forget the function just programmed.
  - Press **Delete** to delete the existing function and forget the function just programmed.

---

# System Features

---

## Introduction

As well as your phones specific features, you can access a number of system features by dialing short codes.

These instructions are for the system's default configuration. They assume that you are using the default feature codes. It also assumes that you have full access to all features and the public telephone network.

---

## Making Calls

### Internal Calls:

If your System Administrator has allocated you the *Ring Back When Free* feature (see RBak+ - Ringback When Free) under a dial pad digit, you can:

1. When you call an extension that does not answer or is busy, press the  **RBak** feature key to set a callback on that extension.
2. When the extension you called becomes free, your phone will ring (a burst of three rings).
3. Lift the handset and the extension is called automatically.
4. When the extension you called is free, your phone will ring (a burst of three rings).
5. Lift the handset and the extension is called automatically.

### External calls:

To make an external call, either dial the number (prefixed by the access code if required) or use a speed dial code (contact your system manager for a list of your speed codes).

If you hear busy tone while dialing, then the call may be barred. Your system manager can bar certain calls, such as those to premium rate numbers and international calls

---

## Answering Calls

### Ringling at your own extension:

Simply pick up the handset. When in headset mode, press the button associated with the alerting call.

The default ringing cadences are:

- Internal calls have a single ring cadence
- External calls have a double ring cadence.

### Ringling at another extension:

You can answer from your own phone by using Call Pick-Up; lift your handset and dial:

- **\*30** to answer a call ringing anywhere.
- **\*31** to answer a call within your group.
- **\*32\*201#** to answer the call for a particular extension, in this example 201.

**Note:** If your phone rings for any longer than a specified period (15 seconds in default), any re-direction feature that you have activated, such as voicemail or call forwarding, will come into effect.

## Call Waiting

Call Waiting tells you if another call arrives while you are already making a call by providing call waiting tone. If you hear the call waiting tone, either end your current call or put the caller on hold. The waiting call should then ring.

To turn call waiting on use the code **\*15**; to turn it off use **\*16**.

---

## Call Forwarding

Your calls can be forwarded to another extension or an external number either when you are away from your desk (on no answer), when your extension is busy (on all Call Appearance keys), and all calls (for example when you go on holiday).

- To set the number to which your calls are forwarded dial **\*07\*201#** (forwarding to 201 in this example).
  - To switch forward direct station calls (i.e. not Hunt Group) on, dial **\*01**. To switch it off dial **\*02**.
  - To switch forward on busy on dial **\*03**, to switch it off dial **\*04**.
  - To switch forward on no answer on dial **\*05**, to switch it off dial **\*06**.
- 

## Diverting Calls

You can divert your calls to another extension.

**Note:** If you do not answer calls at the temporary extension, they are forwarded to your own voicemail or call forwarding number.

### At another extension:

- **\*12\*N#** from the extension you are temporarily using (where **N** is your extension number). Hence, calls to your extension will be diverted to the extension you are temporarily using.
- **\*13\*N#** to re-direct the calls back to your own extension, before you return to it.

### At your own extension:

- **\*14\*N#** from your own extension (where **N** is the extension to which you want your calls diverted).
- **\*14\*#** to cancel either feature from your own extension.

You can divert your calls to another extension. In the examples below **N** is the extension to which you want your calls diverted.

**Note:** If you do not answer calls at the temporary extension, they are forwarded to your own voicemail or call forwarding number.

### At another extension:

- **\*12\*N#** from the extension you are temporarily using.
- **\*13\*N#** to re-direct the calls back to your own extension, before you return to it.

### At your own extension:

- **\*14\*N#** from your own extension.
- **\*14\*#** to cancel either feature from your own extension.

## Do Not Disturb

You may choose to receive no calls at all or only those from particular callers on your exceptions list:

To switch Do Not Disturb on/off (with or without exceptions):

- Dial **\*08** and to switch it off dial **\*09**

or

Dial **\*10\*N#** to add a number to the exception list.

or

- Dial **\*11\*N#** to delete a number from the exception list.

**Note:** Your callers, other than your exceptions, either hear busy tone or are re-directed to your voicemail.

---

## Voicemail

Note that not all systems support voicemail or have voicemail installed.

- To switch voicemail on dial **\*18**, to switch it off dial **\*19**.
- To retrieve your voicemail, use the code **\*17**.

Your voicemail may be set up to deliver your messages by calling you whenever you hang up: this feature is known as *Voicemail Ringback*.

- To turn Voicemail Ringback on dial **\*48**; to turn it off dial **\*49**.

Dialing a number while listening to your messages invokes further facilities:

Once messages have been delivered, they are held on the system for 24 hours (this is fixed for Voicemail Lite, but can be varied by your System Administrator if your IP Office is equipped with VoicemailPro).

You can collect your voicemail from another extension by using the PIN your System Administrator has set up for you. You can collect your messages if you are out of the office, by either dialing from a number that has been registered for the purpose or by dialing your extension number and PIN when prompted. If validation is successful, then dial **1** to retrieve your mail.

The System Administrator also specifies the reception number, to which the call is diverted if the caller dials **0**, and your email address if your voicemail and email are integrated.

## Default Feature Codes

The following are the normal default feature codes available to all users. Your System Administrator may add additional codes for other features and for speed dials.

The **N** where shown, should be replaced by the appropriate number. For example, with **\*07\*N#**, replace **N** with the extension to which you want your calls forwarded when you have forwarding switched on.

*00	Cancel All Forwarding	*32*N#	Call Pick Up Extension
*01	Forward Unconditionally On	*33*N#	Call Queue
*02	Forward Unconditionally Off	*34	Hold Music
*03	Forward on Busy On	*35*N#	Extn Login
*04	Forward on Busy Off	*36*N#	Extn Logout
*05	Forward on No Answer On	*37*N#	Park Call
*06	Forward on No Answer Off	*38*N#	Ride Call
*07*N#	Forward to number	*39	Relay On
*08	Do Not Disturb On	*40	Relay Off
*09	Do Not Disturb Off	*41	Relay Pulse
*10*N#	Do Not Disturb Exception Add	*42	Relay On
*11*N#	Do Not Disturb Exception Delete	*43	Relay Off
*12*N#	Follow Me Here	*44	Relay Pulse
*13*N#	Follow Me Here Cancel	*45*N#	Call Steal
*14*N#	Follow Me To	*46	Call Steal
*15	Call Waiting On	*47	Conference Add
*16	Call Waiting Off	*48	Voicemail Ringback On
*17	Voicemail Collect	*49	Voicemail Ringback Off
*18	Voicemail On	*50	Forward Hunt Group Calls On
*19	Voicemail Off	*51	Forward Hunt Group Calls Off
*20*N#	Set Hunt Group Night Service	*52	Clear Call
*21*N#	Clear Hunt Group Night Service	*53*N#	Call Pickup Members
*29	Toggle Calls	*57*N#	Forward on busy number
*30	Call Pick Up Any	*70*N#	Dial Physical Extn by Number
*31	Call Pick Up Group	*71*N#	Dial Physical Extn by ID



---

# Web Browsing

---

## Overview of Web Browsing

The phone can act as a web browser for WAP (Wireless Application Protocol) web sites. These web sites contain pages written in a language called WML (Wireless Markup Language). The phone supports WML1.2.

If your telephone system has been setup with a default WAP website, the phone will display  **Web**. Pressing this key will display your systems default WAP website. The links and services on this site will control the WAP website and services you can access.





While browsing, you can still make and receive calls. But if you have **Phone Screen on Answer** option set to **Yes** and you answer an incoming call, the default phone screen will replace the existing web page in the display area.

### To enter web browsing mode:

1. Press the  key under **Web**.

### To exit web browsing mode:

1. Press  **Phone Exit**.
2. If  **Phone Exit** is pressed while browsing the web, the last web page viewed will be displayed when  **Web** is pressed again before a system reboot.

---

## Accessing External WAP Websites

Your default WAP web site may contain a page where you can select or enter the URL of external WAP websites. If this is the case, you should be aware that some website may contain information that the phone is not able to display.

If the WAP web page uses WML features that the phone does not support, those features will not be shown.

If the WAP web page uses features that the phone does not recognize as valid WML 1.2, the phone will display **Not a valid WML page**.







## Web Navigation Controls

Having pressed display **Web** to access your default WAP website, the phone display shows a number of navigation controls.





- **Navigation Icon Buttons:**



These appear on the right-hand side of the web display. Note that they may appear grayed out when not useable.

- **▲Up Page:**  
Press the adjacent  key to move up the page by one screen (six lines).
- **↑Up Line:**  
Press the adjacent  key to move up the page by one line.
- **🏠Home:**  
Press the adjacent  key to return to the default WAP website's home page.
- **🔄Refresh:**  
Press the adjacent  key to reload the current page. If you had already selected another page to load this will cancel the loading of that page and reload the current page.
- **↓Down Line:**  
Press the adjacent  key to move down the page by one line.
- **▼Down Page:**  
Press the adjacent  key to move down the page by one screen (six lines).



- **Link Buttons:**

The  keys at the left hand edge of the screen are used to select links within the displayed web page. Links are indicated by underlined text. Only one link will appear on a line and pressing the adjacent  key will activate that link.

- **Page Buttons:**





The  keys across the base of the web display may be used to provide labeled links to other pages. If there are more than 3 such links, the right-hand  key will be labeled as **More**, press this key to display the additional options.

- **Phone Icon:**











If the  icon appears next to a link in the web page, it indicates that the link is a telephone number. Pressing the adjacent  key to select the link will dial the number.

## Entering Data

Some web pages may require you to enter data into a text field and then submit that data. For example, if you browse to a search engine web site like Google, you may be asked to enter a search field.

- **☐: Option (Radio Buttons)**  
These allow you to select an option from a list by clicking on the adjacent left-hand  key. The selected option appears as .
- **[ ] : Text Entry Fields**  
These normally appear as **[Enter text here]** or pre-filled with some data.
- **Submit Buttons**  
Text entry and option key selections are not completed until submitted. Normally this will be done by a link, using a  or  key, labeled as **Submit** or similar. The exact appearance will vary between different web pages.

### To enter text into a [ ] text entry field:

1. Press the left-hand  key adjacent to the [ ] text entry field.
2. The four  keys at the bottom of the screen change to:
  - **DONE:** Press this  key when your text entry is complete.
  - **BKSP:** Press this  key to delete the previous character.
  - **SPACE:** Press this  key to add a space.
  - **alpha:** This indicates the current text entry mode (in this example lower-case letters). Press the  key to select a different text entry mode.
3. Begin entering text using the telephone keypad. Each key is marked with the letters it provides. You may have to press the key more than once depending on the character you require.
  - For example, the **2** key is also marked as **A**, **B** and **C**. To enter a **C** press the key three times.
  - If the next character you want to enter is on the same key, press **1** and then enter the next character.
4. The right-most  key indicates the current text entry mode. To change the current mode, press the right-hand key. The available modes are shown along the bottom of the screen. They are:
  - **ALPHA:** Enter upper-case letters using the telephone keypad.
  - **alpha:** Enter lower-case letters using the telephone keypad.
  - **Num:** Enter numbers using the telephone keypad.
  - **Symbol:** Enter a symbol from the displayed menu. Possible symbols are: . , # @ \* ' " ; : \ / - | \$ % ! ? & + = > < ( ) ~ \_ ^ [ ] { }. These are arranged in pages and you may have to press **MORE**  to select the required page. To enter a symbol, press the  key next to it.
5. When you have completed your text entry, press  **DONE** .
6. You can return to text entry by pressing the left-hand  key adjacent to the [ ] text entry field again.

---

# Management and Troubleshooting

---

## Overview

This chapter provides helpful information for:

- Testing your telephone to be sure it is operating correctly.
- Basic Troubleshooting; this chart provides the most common problems an end user might encounter and suggested resolutions.
- Application-specific troubleshooting; this chart describes problems and solutions specific to phone applications; Speed Dial, Call Log, or Web Access.
- Resetting or power-cycling your phone, when Basic Troubleshooting does not resolve a problem.



---

## Testing the Telephone's Lights and Display

1. With the telephone idle (on-hook), press and release the  **Mute** button, then press the following numbers on the dialpad: 8 3 7 8 # (which stands for TEST).
  - The display should indicate the self-test has started. If the test is successful, the message "Self test Passed #=end" displays; if the test is not successful, the message "Self test Failed #=end" displays instead.
2. Press # to return to the Phone screen.
  - If nothing appears on the display and the phone is receiving power, your phone may need to be replaced. Contact your System Administrator for assistance or additional troubleshooting information.

---

## Troubleshooting

- **Phone does not activate when connected for the first time:**  
Unless your System Administrator has already initialized your telephone, you may experience a delay of several minutes before it becomes operational. Upon plug-in, your telephone immediately begins downloading its operational software, its IP address, and any special features programmed by your System Administrator from the server to which it is connected. Report any delay of more than 10 minutes to your System Administrator.
- **Phone does not activate after a power interruption:**  
Allow a few minutes for re-initialization after unplugging, powering down the phone, server problems, or other power interruption causes.
- **Display shows an error/informational message:**  
Most messages involve server/phone interaction. If you cannot resolve the problem based on the message received, contact your System Administrator for resolution.
- **Speakerphone does not operate:**  
Ask your System Administrator if your Speakerphone has been disabled.
- **Characters do not appear on the display screen:**
  - See "Phone does not activate when connected for the first time" above.
  - Check all lines into the phone to be sure it is properly connected.
  - Check the power source to be sure your telephone is receiving power.
  - Perform the following Test procedure: with the telephone idle (on-hook), press and release the  **Mute** button, then press the following numbers on the dialpad: **8 3 7 8 #** (which stands for TEST). The display should indicate the self-test has started, then report if the test was successful or failed. If nothing appears on the display, and the phone is receiving power, your phone may need to be replaced.
  - If the above suggested solutions do not resolve the problem, reset or power cycle the phone with your System Administrator's assistance.
- **No dial tone:**  
Make sure both the handset and line cords into the phone are securely connected. Note that there may be a slight operational delay if you unplug and reconnect the phone. Contact your System Administrator if the problem persists.
- **Phone does not ring:**  
Set your ringer volume to a higher level using the  and  **Up/Down Volume** keys. From another phone, place a call to your extension to test the above suggested solution.
- **All other IP problems:**  
Contact your System Administrator.

### **SPEED DIAL APPLICATION:**

- **You cannot dial out using any Speed Dial entries:**  
Dial button. Check that all call appearances (incoming/outgoing lines) are not already in use. If all lines are in use, wait until a line is available to make your call.
- **You cannot add an entry to the Speed Dial list:**  
You have 108 Speed Dial entries, the maximum allowed. You must delete at least one entry before adding a new entry.

### **CALL LOG APPLICATION:**

- **You cannot dial out after selecting a call log entry:**  
Check that all call appearances incoming/outgoing lines) are not already in use. If all lines are in use, wait until a line is available to make your call.
- **You cannot add an entry to the Speed Dial list:**  
You have 108 Speed Dial entries, the maximum allowed. You must delete at least one entry before adding a new entry.
- **Dialing from this application does not go through:**  
Your administrator must administer settings for the Enhanced Dialing feature beyond the defaults.

### **WEB APPLICATION:**

- **Pressing the  Web soft key does not display a website:**  
Check with your LAN Administrator to see if the web server is down, if there are network connectivity problems, or other network problems.
- **Dialing from this application does not go through:**  
Your administrator must administer settings for the Enhanced Dialing feature beyond the defaults.

### **OPTIONS:**

- **No Options other than "View IP Settings" display:**  
Your administrator has turned off all user-settable options.

# Index

- 0**
- 07\*N 32
- 1**
- 10\*N 32
- 11\*N 32
- 12\*N 30, 32
- 13\*N 30, 32
- 14\*N 30, 32
- 2**
- 20\*N 32
- 201
  - forwarding 30
- 21 Function Keys 6
  - remaining 6
- 21\*N 32
- 3**
- 30
  - includes 16
- 32\*N 32
- 33\*N 32
- 35\*N 32
- 36\*N 32
- 37\*N 32
- 38\*N 32
- 4**
- 45\*N 32
- 5**
- 53\*N 32
- 57\*N 32
- 7**
- 70\*N 32
- 71\*N 32
- A**
- Abbreviated Dial 6, 26
- Abbreviated Dial Program 26
- Access 4, 9, 13, 17, 33
  - Call Log 9, 17
  - External WAP Websites 33
  - Speaker 4
  - Speed Dial Directory/Dialing 13
  - Speed Dial List 9
- Account Code Entry 26
- Acct 26
- AD 26
- AD Suppress 26
- Adding 13, 14, 15
  - New Speed Dial 15
  - Pressing 13
  - Speed Dial 14
- Adjust 10
  - speakerphone 10
- Admin 25, 26, 27, 28
- Admin key 26
- Admin Pages 27
- Admin1 25, 26
- Admin1 key 26
- Admin1 menu 27
- Admin1 Page 27
- Administrator' 7
- ALPHA 35
- And/or 6, 8, 20
- Answer Incoming Calls 8
- Answer/make 6
- Answering 29
  - Calls 29
- Apostrophe - Insert 15
- Appearance' 6
- Applications Options 23
- Application-specific 36
- AutCB 26
- Automatic Callback 26
- Avaya 4
- Avaya 5620 4
- Avaya IP Office 4
- B**
- Backspace - Delete 15
- Basic Troubleshooting 36
- BKSP 35
- Both , Function Keys 25
- Both Admin 26
- Bridged 6
- Bridged Appearance 6
- Busy Off 32
- Busy On 32
- BUTTON PROGRAMMED 27, 28
- C**
- Call Appearance 6, 24, 25, 30
- Call Appearance Keys 4, 6
  - replace 6
- Call Appearance Keys Icons Icons 7
- Call Appearance Width 24
- Call Appearance/Feature button 12, 23, 24
  - Press 12
- Call
- Appearance/Feature Keys 7
- Call Coverage Appearance 6
- Call Coverage Appearance Keys 6
- Call Forwarding 30
- Call Forwarding All 26
- Call Handling Buttons 4
- Call Log 9, 14, 16, 17, 18, 20, 36
  - Access 9, 17
  - Exit 18
  - Overview 16
- CALL LOG APPLICATION 37
- Call Park 26
  - Other Extension 26
- Call Pick Up Any 32
- Call Pick Up Extension 32
- Call Pick Up Group 32
- Call Pickup 26
- Call Pick-Up 29
- Call Pickup Members 32
- Call Queue 32
- Call Steal 32
- Call Waiting 30
- Call Waiting Off 32
- Call Waiting On 32
- Calling 7, 8, 18, 23, 29, 30
  - Answering 29
  - Clearing 8
  - Diverting 30
  - Incoming 7
  - Make 8
  - Making 18, 29
- Cancel 14, 18, 20, 23, 24
  - press 20
- Cancel - Return 15
- Cancel All Forwarding 32
- Case - Change 15
- CAUTION 20
- CAUTIONS 6
- CFrwd 26
- Change 12, 19, 23
  - Display Call Timers 23
  - Personal Ringing 19
  - Soft Hold icon 12
- Clear - Delete 15
- Clear Call 32
- Clear Hunt Group Night Service 32
- Clearing 8
  - Call 8
- Colleague. 6
  - System Feature 6
- Colleague's 6
- Comma - Insert 15
- Conference 12
- Conference Add 32
- Conference button 12
  - Press 12
- Contrast Control 20
- Control 33
  - WAP website 33
- CPark 26
- CPkUp 26
- Current Pattern 19
- D**
- Data 35
  - Entering 35
- Day 26
- Default Feature Codes 32
- Delet 27, 28
- Delete 14, 18
  - Individual Log Entry 18
  - Speed Dial 14
- Delete All Entries 18
- DeleteAll 18
- Deutsche 22
- Dial \*10\*N 31
- Dial \*11\*N 31
- Dial Physical Extn 32
- Dialpad 20, 36, 37
  - use 20
- Dir 26
- Directed Call Pickup 26
- Display 4, 17, 36, 37
  - Individual Log Entry 17
  - Options 4
  - website 37
- Display Call Timers 23
  - change 23
- Display Language Selection 22
- Diverted 17, 30
  - Calls 30
  - voicemail 17
- Do Not Disturb on/off 31
- Done 35
- Down Line 34
- Down Page 34
- DPkUp 26
- Drop button 12
  - Press 12

- E**  
 Editing 13, 14  
   Speed Dial 14  
 Email 31  
 Ending 10  
   speakerphone 10  
 English 22  
 Enhanced Dialing 37  
 Enter 33, 35  
   Data 35  
   URL 33  
 Error/informational 37  
   shows 37  
 Español 22  
 Except 23  
   Web Access  
   application 23  
 EXIT 18  
   Call Logs 18  
 Exlp 26  
 Expl 27, 28  
   Pressing 27, 28  
 Extension 20  
 External WAP  
 Websites 33  
   Accessing 33  
 Extn Login 32  
 Extn Logout 32
- F**  
 Failed 36  
 Fast 24  
 Feature 4  
 Feature Button  
 Labeling 21  
 FEATURE ON  
 BUTTON 27, 28  
 File Server 19  
 Follow Me Here 32  
 Follow Me Here  
 Cancel 32  
 Follow Me To 32  
 Forward Hunt Group  
 Calls Off 32  
 Forward Hunt Group  
 Calls On 32  
 Forward  
 Unconditionally Off  
 32  
 Forward  
 Unconditionally On  
 32  
 Forwarding 30  
   201 30  
 Français 22  
 Full 24  
   set 24  
 Function Active 7  
 Function Key  
 Programming 26  
 Function Keys 6, 7,  
 25  
   Overview 25
- System  
 Administrator 25
- G**  
 Google 35  
 Group Paging 26  
 GrpPg 26
- H**  
 Half 24  
   set 24  
 Hash 20  
   Press 20  
 HdSet 26  
 Headset 9  
 Headset Toggle 26  
 Headset Working 9  
 HfAns 26  
 HGNS 26  
 Hold 7, 11  
   Press 11  
 Hold icon 12  
 Hold Music 32  
 Home 11  
 Hook Flash 26  
 Hunt Group 30
- I**  
 ID 32  
 le 15, 17  
 InAns 17, 18  
 Includes 16  
   30 16  
 Incoming 7  
   Call 7  
 Incoming/outgoing 37  
 Individual Log Entry  
 17, 18  
   Delete 18  
   Display 17  
 Internal Auto-Answer  
 26  
 Internal Calls 29  
 Internet Protocol 19  
 Introduction 29  
 IP 6, 19, 37  
 IP Address 19  
 IP Address Settings  
 19  
 IP Office 4, 6, 12, 19,  
 20, 21, 24, 31  
 IP Office Key 6  
   refer 6  
 Italiano 22
- J**  
 Japanese 22
- K**  
 Katakana 22  
 Keep 27, 28
- L**  
 Labeling 23  
   Speed Dial button  
   23  
 Lamp Operation 6
- LAN Administrator 37  
 Language 22  
 LED 4  
 LED Indicator 4  
 Line 6, 34  
 Line Appearance 6  
 Line/Feature button  
 11  
 Link Buttons 34  
 Log 16, 17, 18, 20,  
 25  
   Off 20  
   selecting 16  
 Log Entry into 18  
   Turn 18  
 Log Off 20  
 Longhand  
 Programming Mode  
 28
- M**  
 Making 8, 18, 29  
   Call 8  
   Calls 18, 29  
 Message Display  
 Rate 24  
 Meter 4  
 Miscellaneous  
 Information 19  
 Missed 17, 18  
 Mode' 8  
 More 34, 35  
 Mute 10  
 Mute button 10, 36,  
 37  
   release 36, 37
- N**  
 Name 15  
 Name/phone 4  
 Navigation Icon  
 Buttons 34  
 Nederlands 22  
 New Speed Dial 15  
   Adding 15  
 No  
   Selecting 20  
   set 23, 24  
 No Answer Off 32  
 No Answer On 32  
 Non-English 22  
 Not Disturb 31  
 Not Disturb Exception  
 Add 32  
 Not Disturb Exception  
 Delete 32  
 Not Disturb Off 32  
 Not Disturb On 32  
 NOTE 20  
 Num 35  
 Number 7, 15, 25, 32  
   System Features  
   7, 25
- O**  
 Off 20
- Logging 20  
 On/off 25  
 Option 4, 25  
   Displays 4  
 OPTIONS 23, 37  
 Options Main 19, 23,  
 24  
 Options menu 4, 20  
 Other Extension 26  
   Call Park 26  
 Outgo 17, 18  
 Overview 13, 16, 25,  
 33, 36  
   Call Log 16  
   Function Keys 25  
   Speed Dials 13  
   Web Browsing 33
- P**  
 Page 34  
 Page Buttons 34  
 Page Left 13, 14, 16,  
 17  
   Use 17  
 Page Right 13, 14,  
 16, 17  
 Page Right/Left 4  
 Park Call 32  
 Passed 36  
 PBX/switch  
 Password 20  
 Personal Ringing 19  
   change 19  
 Phone 20, 36  
   Reinstating 20  
   return 36  
 Phone Exit 13, 14,  
 15, 17, 33  
 Phone Icon 34  
 Phone Interface 19  
 Phone Screen 23  
   select 23  
 Phone Screen on  
 Answer 23, 33  
 Phone Screen on  
 Calling 23  
 Phone/Exit 4  
 PIN 31  
 Português 22  
 Prefilled 18  
 Press Add 15, 18  
   SD 18  
 Press Admin 27, 28  
 Press Call 18  
 Press Cancel 14, 18  
 Press Conference 18  
 Press Cont 27, 28  
 Press Delete 14, 18,  
 27, 28  
 Press Drop 8, 9  
 Press Edit 14  
 Press EXIT 27, 28  
 Press Keep 27, 28  
 Press Missed 18  
 Press Mute 10



- Press Next 28  
 Press Option 19  
 Press Phone Exit 18, 33  
 Press Redial 9, 11, 23  
 Press Repla 27, 28  
 Press SpDial 13, 14, 15  
 Press Transfer 12  
 Pressing 11, 12, 13, 19, 20, 27, 28, 29, 37  
   Add 13  
   Call Appearance/Feature button 12  
   Cancel 20  
   Conference button 12  
   Drop button 12  
   Expl 27, 28  
   Hash 20  
   Hold 11  
   RBak 29  
   Save 19, 20  
   SpDial softkey 11  
   Transfer 12  
   Web 37  
 Proceed 12  
   Step 12  
 Prog 26  
 Programming 25  
   Your Own Features 25
- Q**
- QoS 19
- R**
- Radio Buttons 35  
 RBak 29  
   press 29  
 Redial 4, 11  
 Redials 4, 11  
 Refer 6  
   IP Office Key 6  
 Re-initialization 37  
 Reinstating 20  
   Phone 20  
 Relay Off 32  
 Relay On 32  
 Relay Pulse 32  
 Release 36, 37  
   Mute button 36, 37  
 Remaining 6  
   21 Function Keys 6  
 Repeat Step 12, 19  
 Repla 27, 28  
 Replace 6
- Call Appearance Keys 6  
 Return 19, 22, 36  
   Phone 36  
 Ride Call 32  
 Ring Back When Free 29  
 Ringer Off 26  
 RngOf 26
- S**
- SAC 25, 26  
   set 25  
 Save 15, 18, 19, 20  
   pressing 19, 20  
 Save - Save 15  
 SD 18  
   Press Add 18  
 See 4, 27  
 See 37  
 See Function Keys 6  
 See Using Speed Dials 8  
 Selct 28  
 Select 13, 16, 20, 23  
   Log 16  
   No 20  
   Phone Screen 23  
   SpDial 13  
 Select Delete 18  
 Select Save 23, 24  
 Select Yes 20  
 Self 36  
 Self-Administer 26  
 Send All Calls 25, 26  
 Server/phone 37  
 Service 19  
 Set 23, 24, 25, 33  
   Full 24  
   Half 24  
   No 23, 24  
   SAC 25  
   VMOOn 25  
   Yes 23, 24, 33  
 Set Hunt Group Night Service 26, 32  
 Shorthand Programming Mode 27  
 Shows 37  
   error/informational 37  
 Slow 24  
 Soft Hold icon 12  
   changes 12  
 Soft Keys 25  
 Softkeys 4  
 SPACE 35  
 Space - Insert 15  
 SpDial 13, 14, 15, 25  
   selecting 13  
   SpDial softkey 11  
   press 11  
 Speaker 4  
   Accesses 4  
 Speakerphone 8, 10, 37  
   Adjust 10  
   Ending 10  
   use 8  
 Speakerphones 10  
 Speed Dial 11, 13, 14, 18, 36, 37  
   Adding 14  
   Deleting 14  
   Editing 14  
   Overview 13  
 SPEED DIAL APPLICATION 37  
 Speed Dial button 23  
   labeling 23  
 Speed Dial Directory/Dialing 13  
   Accessing 13  
 Speed Dial list 9, 37  
   Access 9  
 Spres 26  
 Stands 36, 37  
   TEST 36, 37  
 Step 12  
   proceed 12  
 Submit 35  
 Submit Buttons 35  
 Sure? 22  
 System Administrator 6, 7, 19, 20, 25, 26, 29, 31, 32, 36, 37  
   Function Keys 25  
 System Features 6, 7, 25  
   colleague. 6  
   number 7, 25
- T**
- Telephone's Lights 36  
   Testing 36  
 Test 36, 37  
   stands 36, 37  
   Telephone's Lights 36  
 Text Entry Fields 35  
 TmDay 26  
 Toggle Calls 32  
 Transfer 12  
   press 12  
 Turn 18  
   Log Entry into 18
- U**
- Up/Down Volume 37  
 Upon 24  
 URL 33  
   enter 33
- Use 8, 17, 20  
   dialpad 20  
   Page Left 17  
   speakerphone 8  
 User-settable 37  
 Using Return key 17
- V**
- View IP Settings 19, 37  
 Visual Alerting 24  
 VMOOn 25  
   set 25  
 Voicemail 4, 7, 17, 25, 29, 30, 31  
   diverted 17  
 Voicemail Collect 32  
 Voicemail Life 31  
 Voicemail Off 32  
 Voicemail On 32  
 Voicemail ringback 31  
 Voicemail Ringback Off 32  
 Voicemail Ringback On 32  
 VoicemailPro 31  
 Volume Controls 4
- W**
- WAP 33  
 WAP website 33, 34  
   control 33  
 WAP websites 33  
 Web 33, 34, 37  
   Pressing 37  
 Web Access 36  
 Web Access application 23  
   except 23  
 WEB APPLICATION 37  
 Web Browsing 33  
   Overview 33  
 Web Navigation Controls 34  
 Website 33, 37  
   display 37  
 Wireless Application Protocol 33  
 Wireless Markup Language 33  
 WML 33  
 WML 1.2 33  
 WML1.2. 33
- Y**
- Yes 22, 23, 24, 33  
   set 23, 24, 33  
 Your Own Features 25  
   Programming 25

Performance figures and data quoted in this document are typical, and must be specifically confirmed in writing by Avaya before they become applicable to any particular order or contract.

The company reserves the right to make alterations or amendments to the detailed specifications at its discretion. The publication of information in this document does not imply freedom from patent or other protective rights of Avaya or others.

Intellectual property related to this product (including trademarks) and registered to Lucent Technologies have been transferred or licensed to Avaya.

All trademarks identified by the ® or ™ are registered trademarks or trademarks, respectively, of Avaya Inc. All other trademarks are the property of their respective owners.

This document contains proprietary information of Avaya and is not to be disclosed or used except in accordance with applicable agreements.

Any comments or suggestions regarding this document should be sent to "wgctechpubs@avaya.com".

© 2005 Avaya Inc. All rights reserved.

Avaya  
Unit 1, Sterling Court  
15 - 21 Mundells  
Welwyn Garden City  
Hertfordshire  
AL7 1LZ  
England

Tel: +44 (0) 1707 392200  
Fax: +44 (0) 1707 376933

Web: <http://www.avaya.com/ipoffice/knowledgebase>