



USER GUIDE



Cisco Unified IP Phone Guide 3951 (SIP) User Guide for Cisco Unified Communications Manager Express 4.1

- 1** Overview
- 2** Operating Your Phone
- 3** Phone Features and Functions List

1 Overview



This guide provides phone, soft key, and features descriptions for the Cisco Unified IP Phone model 3951.



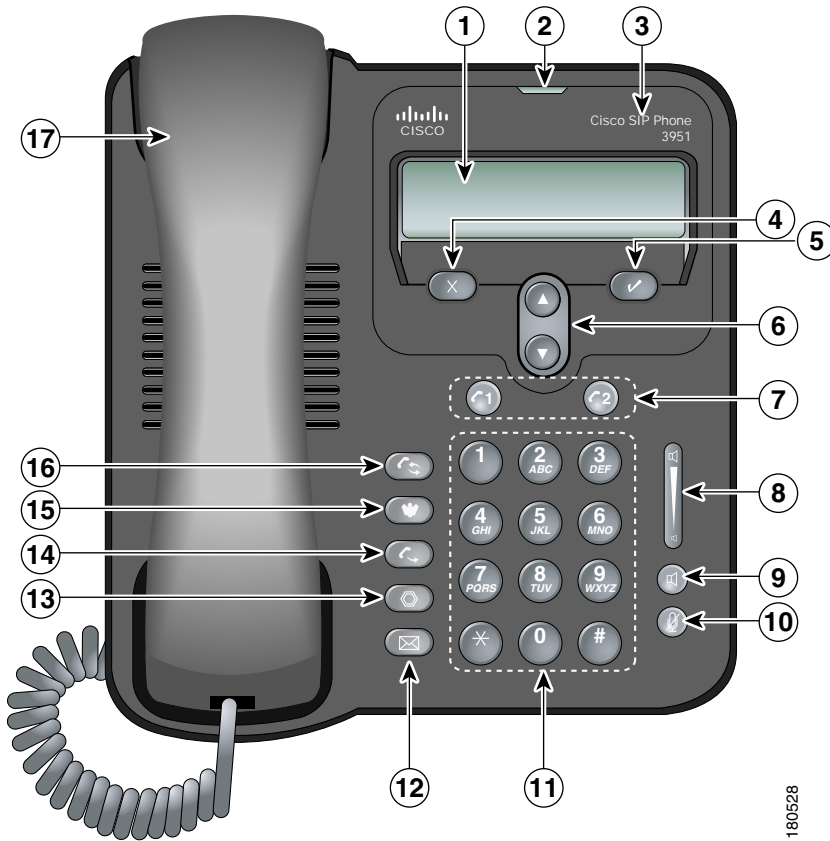







Physical Layout

The Cisco Unified IP phone 3951 is a single-line phone. Buttons near the handset provide direct access to several features.



180528

	Item	Description
1	Phone screen	Displays phone menus and call activity including caller ID (phone number), call duration, and call state.
2	Message waiting indicator	Indicates new voice message (steady red) or an incoming call (blinking).
3	Phone model	The Cisco Unified IP Phone model.
4	Cancel button 	Cancels an action, exits a menu, or hangs up a call.
5	OK button 	Displays menus, selects or confirms a menu option, answers a call, or resumes a call.

6	Navigation button 	Allows you to scroll through menu items and highlight items. When the phone is on-hook, displays the call logs (Missed Calls, Received Calls, Placed Calls) and your Speed Dials.
7	Line buttons 	Allows you to select a line for making a call or to answer a call on the line. <ul style="list-style-type: none"> • A fast blink indicates an incoming call. • A slow blink indicates a held call.
8	Volume button 	Controls the handset, headset, speakerphone, and ringer volume.
9	Speaker button 	Selects the speakerphone. When the speakerphone is on, the button is lit.
10	Mute button 	Mutes the speakerphone and handset. If the button is lit, the speaker and handset are muted.
11	Keypad	Allows you to dial phone numbers, and enter numbers or letters.
12	Message button 	Connects to your voice mail box. If the button is lit, you have a message waiting.
13	Hold button 	Places the current call on hold, resumes a call that was held, and switches between an active call and a call on hold. If the button is lit, you have a call on hold.
14	Transfer button 	Transfers a call to another number.
15	Conference button 	Starts a standard (ad hoc) conference call. If the button is lit, a conference call is taking place.
16	New Call/Redial button 	Makes a new call or redials the last called number.
17	Handset	Phone handset.

Connecting Your Phone

This section shows how to use the connectors on your Cisco IP phone.

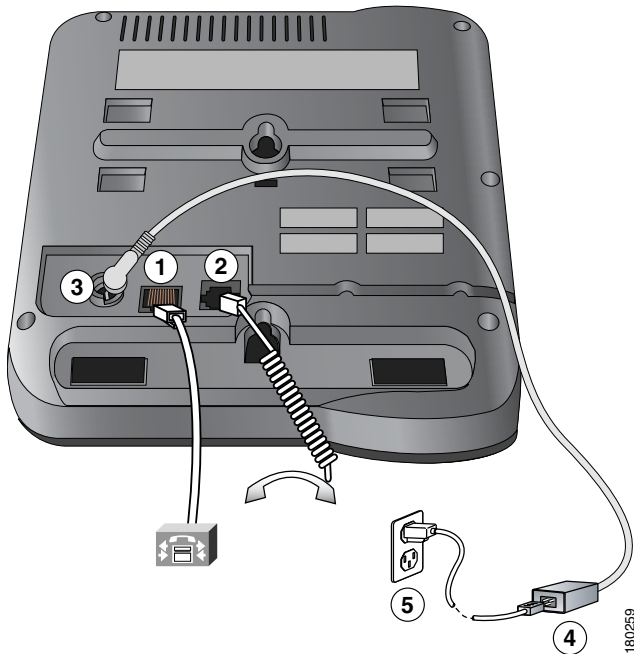

1	Network port (10/100 SW)
2	Handset port
3	DC adapter port (DC48V)
4	AC-to-DC power supply
5	AC power cord

Adjusting the Handset Rest

When you connect your phone, you can adjust the handset rest so that the receiver will not slip out of the cradle. Use the following method to adjust the handset:

1. Set the handset aside and pull the square plastic tab from the handset rest.
2. Rotate the tab 180 degrees.
3. Slide the tab back into the handset rest. An extension protrudes from the top of the rotated tab. Return the handset to the handset rest.

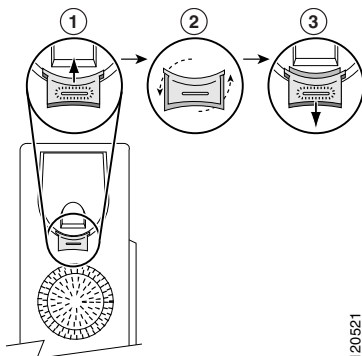

2 Operating Your Phone

This section describes how to operate your Cisco Unified IP phone. Because there are differences in phone and site configuration, not all features and procedures described here may apply to your phone. Consult your system administrator for more information. This section includes:



Note In the following procedures, you may be required to enter information using the keypad. Press the backspace (<<) soft key to erase digits that were entered incorrectly.

This section describes how to operate your Cisco Unified IP phone. Because there are differences in phone and site configuration, not all features and procedures described here may apply to your phone. Consult your system administrator for more information.

Place a Call, Basic

1. Select a phone line
2. Press or .
3. Dial number.

Place a call using the handset

1. Pick up the handset or press , then dial the number.

Dial on-hook (with dial tone)

1. Press or , then dial the number.
2. Use the speakerphone (if already activated) or pick up the handset.

Redial a number

Press .

Place a call when another call is active

Press and dial the number. The other call is placed on hold.

Dial from a call log

1. Do one of the following:
 - Press the Navigation button and choose **Missed Calls**, **Received Calls**, or **Placed Calls**.
 - Press and choose **Directories > Missed Calls**, **Received Calls**, or **Placed Calls**.
2. Select a number, then select **Dial**.

Answer a Call

You can answer a call by simply selecting the line with the incoming call and lifting the handset

Answer a Call, Speakerphone

1. Press the line button, if not already selected.
2. Press .

Switch from a connected call to answer a new call on the same line

Press  or the line button.

Switch from a connected call to answer a new call on the other line

Select the other line.

Answer a priority call

Hang up the current call and press Answer.

Ending a Call

To end a call, hang up. Here are some more details.



Hang up while using the handset

Return the handset to its cradle.

Hang up while using the speakerphone

Press .

Hang up one call, but preserve another call on the same line

Press . If necessary, remove the call from hold first by pressing .

Hold and Resume

Only one call can be active at any given time; all other connected calls must be placed on hold

Put a call on hold

1. Make sure the call you want to put on hold is highlighted.
2. Press .

Remove a call from hold

1. Make sure the appropriate call is highlighted.
2. Press .

Engaging the Hold feature typically generates music or a beeping tone.

A held call is indicated by the call-on-hold icon: .

The line button with a held call blinks slowly.

Mute

With Mute enabled, you can hear other parties on a call but they cannot hear you. You can use Mute in conjunction with the handset or speakerphone.

Toggle Mute on or off

Press .

Switching Between Multiple Calls

You can switch between multiple calls on your phone.

Switch between connected calls on one line

1. Make sure the call that you want to switch to is highlighted.
2. Press . Any active call is placed on hold and the selected call is resumed.

Switch between connected calls on different lines

1. Select the other line. Any active call is placed on hold.
2. Make sure the call that you want to switch to is highlighted and press .

Switch from a connected call to answer a ringing call on the same line

Press  or the line button.

Switch from a connected call to answer a ringing call on the other line

1. Press the line button with the incoming call.
2. Press .

Viewing Multiple Calls

Understanding how multiple calls are displayed on your phone can help you organize your call-handling efforts.



Your phone displays calls as follows for the highlighted line:

- Calls with the longest duration display at the top of the list.
- Calls of a similar type are grouped together. For example, calls that you have interacted with are grouped near the top, and calls on hold are grouped last.

Transferring Calls

Transfer redirects a connected call. The *target* is the number to which you want to transfer the call.



Transfer a call without talking to the transfer recipient

1. From an active call, press .
2. Enter the target number.
3. Press  again to complete the transfer, or press  to cancel.



Note If the transfer is cancelled, press  to resume the call.

Talk to the transfer recipient before transferring a call (consult transfer)

1. From an active call, press .
2. Enter the target number. Wait for the transfer recipient to answer.
3. Press  again to complete the transfer, or press  to cancel.





Note If the transfer is cancelled, press  to resume the call.

Transfer two current calls to each other (direct transfer) without staying on the line

1. Scroll to highlight any call on the line.
2. Press **Select**.
3. Repeat this process for the second call.
4. With one of the selected calls highlighted, press **DirTrfr**. (To display **DirTrfr**, you might need to press **more**.) The two calls connect to each other and drop you from the call.

If you want to stay on the line with the callers, use **Join** instead.

If on-hook transfer is enabled on your phone, you can either hang up to complete the call, or press  and then hang up. You cannot transfer a call on hold. Press  again to remove the call from hold before transferring it.

Forwarding All Calls to Another Number

You can use Call Forward All to redirect incoming calls from your phone to another number.

Set up call forwarding on your line

1. Press  and choose **Settings > User Preferences > CFwdALL**.
2. Enter the call forward target number.

Cancel call forwarding on your line

Press  and choose **Settings > User Preferences > CFwdALL**.

Verify that call forwarding is enabled on your line

On the phone screen, look for:

- Call forwarding icon  .
- Call forward target number next to the call forwarding icon.

Enter the call forward target number exactly as you would dial it from your phone. For example, enter an access code or the area code, if necessary.



You can forward your calls to a traditional analog phone or to another IP phone, although your system administrator might restrict the call forwarding feature to numbers within your company.

Call forwarding is phone line specific. If a call reaches you on a line where call forwarding is not enabled, the call rings as usual. Your system administrator can change call forwarding conditions for your phone line.

Making Conference Calls

Your Cisco Unified IP Phone allows you to join three people into one telephone conversation, creating a conference call.

Create a conference by adding a participant

1. From a connected call, press  .
2. Enter the participant's phone number.
3. Wait for the call to connect.
4. Press  again to add the participant to your call.

Create a conference by joining two or more existing calls

1. Make sure that you have two or more calls on a single line.
2. Highlight a call that you want to add to the conference.
3. Press **Select**. The selected call displays this icon .
4. Repeat this process for each call that you want to add.
5. From one of the selected calls, press **Join**. (You may need to press the **more** softkey to see **Join**.)



Note The active call is automatically selected.

Participate in a conference

Answer the phone when it rings.

End your participation in a conference

Hang up. If you leave a conference after creating it, the conference ends.

Speed Dialing

Speed dialing allows you to select a phone screen item to place a call.

Set up Speed Dials

1. Press  and choose Directories > Speed Dials.
2. Select an empty speed dial (shown as None).
3. Choose **Edit** and enter a speed dial number.
4. Enter a name for the speed dial.

Use Speed Dials

To place a call, press the Navigation button and choose **Speed Dials**.

If you make a mistake entering a number or name, press  to erase digits or letters.

When you are entering numbers and letters, press # to switch from numbers to letters, and from uppercase letters to lowercase letters.

Customizing the Phone

You can adjust the ringer volume for your phone and customize the contrast on your phone screen.

Adjust the volume level for the phone ringer

Press the Volume button while the handset is in the cradle. The new ringer volume is saved automatically.

Change the contrast on the phone screen

1. Press  and choose Settings > User Preferences > Contrast.
2. Press the Navigation button to set the contrast.

Using Call Logs

Your phone maintains logs of your missed, placed, and received calls.

View your call logs

Press , and choose Directories > Missed Calls, Placed Calls, or Received Calls.



Erase a call from the call log

1. Press , and choose Directories > Missed Calls, Placed Calls, or Received Calls.
2. Select a call record, then select Delete.

Dial from a call log (while not on another call)

1. Press  and choose Directories > Missed Calls, Placed Calls, or Received Calls.
2. Select a call record from the log, press , and choose Dial.

Dial from a call log (while connected to another call)

1. Press  and choose Directories > Missed Calls, Placed Calls, or Received Calls.
2. Select a call record from the log.
3. Press . The other call is placed on hold.

Using Call Logs

Your phone maintains logs of your missed, placed, and received calls.

View your call logs

Press , and choose Directories > Missed Calls, Placed Calls, or Received Calls.



Erase a call from the call log

1. Press , and choose Directories > Missed Calls, Placed Calls, or Received Calls.
2. Select a call record, then select Delete.

Dial from a call log (while not on another call)

1. Press  and choose Directories > Missed Calls, Placed Calls, or Received Calls.
2. Select a call record from the log, press , and choose Dial.

Dial from a call log (while connected to another call)

1. Press  and choose Directories > Missed Calls, Placed Calls, or Received Calls.
2. Select a call record from the log.
3. Press . The other call is placed on hold.

Accessing Voice Messages

To access voice messages, select the line and press .





Note Your company determines the voice message service that your phone system uses. For the most accurate and detailed information, refer to the documentation that came with your voice message service.

Set up and personalize your voice message service

For each line, press  and follow the voice instructions.



See if you have a new voice message



Look for:

- A steady red light on your message waiting indicator (above your phone screen).
- A steady green light on the Messages () button.
- A message waiting icon  on your phone screen for the line selected.

Listen to your voice messages or access the voice messages menu

Press , and follow the voice instructions.

If there is a message on the active line, pressing  connects you to your voicemail box on this line. If there are no messages on the active line but you have a message on the other (inactive) line, pressing  connects you to the voicemail box on the inactive line. If there are no messages on either line, pressing  connects you to the voicemail box of the active line.

While the Messages button  lights up if there is a message on either line, only the line with a message displays the message waiting icon . You have access only to the voice mail box of the line with a message.

Using a Handset and Speakerphone

You can use your phone with a handset or speakerphone.

Use the speakerphone

Press  to toggle speakerphone mode on or off.

Switch to the speakerphone (from the handset) during a call.

Press , then hang up the handset.

Switch to the handset (from a speakerphone) during a call

Lift the handset without pushing any buttons.

Adjust the volume level for a call

Press the up or down **Volume** button during a call or after invoking a dial tone.

This action adjusts the volume for the handset or speakerphone, depending on which device is in use.

3 Phone Features and Functions List

The following is an alphabetical list of features and functions for your IP phone.

- [Accessing Voice Messages 13](#)
- [Adjust the volume level for a call 13](#)
- [Answer a Call 7](#)
- [Answer a Call, Speakerphone 7](#)
- [Customizing the Phone 11](#)
- [Dial from a call log 7](#)
- [Dial on-hook \(with dial tone\) 6](#)
- [Ending a Call 7](#)
- [Forwarding All Calls to Another Number 10](#)
- [Hold and Resume 7](#)
- [Making Conference Calls 10](#)
- [Mute 8](#)
- [Place a call using the handset 6](#)
- [Place a call when another call is active 7](#)
- [Place a Call, Basic 6](#)
- [Redial a number 6](#)
- [Speed Dialing 11](#)
- [Switching Between Multiple Calls 9](#)
- [Transferring Calls 9](#)
- [Using a Handset and Speakerphone 13](#)
- [Using Call Logs 12](#)
- [View your call logs 12](#)
- [Viewing Multiple Calls 9](#)



Americas Headquarters
Cisco Systems, Inc.
170 West Tasman Drive
San Jose, CA 95134-1706
USA
www.cisco.com
Tel: 408 526-4000
800 553-NETS (6387)
Fax: 408 527-0883

Asia Pacific Headquarters
Cisco Systems, Inc.
168 Robinson Road
#28-01 Capital Tower
Singapore 068912
www.cisco.com
Tel: +65 6317 7777
Fax: +65 6317 7799

Europe Headquarters
Cisco Systems International BV
Haarlerbergpark
Haarlerbergweg 13-19
1101 CH Amsterdam
The Netherlands
www-europe.cisco.com
Tel: 31 0 800 020 0791
Fax: 31 0 20 357 1100

Cisco has more than 200 offices worldwide. Addresses, phone numbers, and fax numbers are listed on the Cisco Website at www.cisco.com/go/offices.

Cisco, Cisco Systems, the Cisco logo, and the Cisco Systems logo are registered trademarks or trademarks of Cisco Systems, Inc. and/or its affiliates in the United States and certain other countries. All other trademarks mentioned in this document or Website are the property of their respective owners. The use of the word partner does not imply a partnership relationship between Cisco and any other company. (0705R)

